

# Digitimer

# D330 MultiStim System

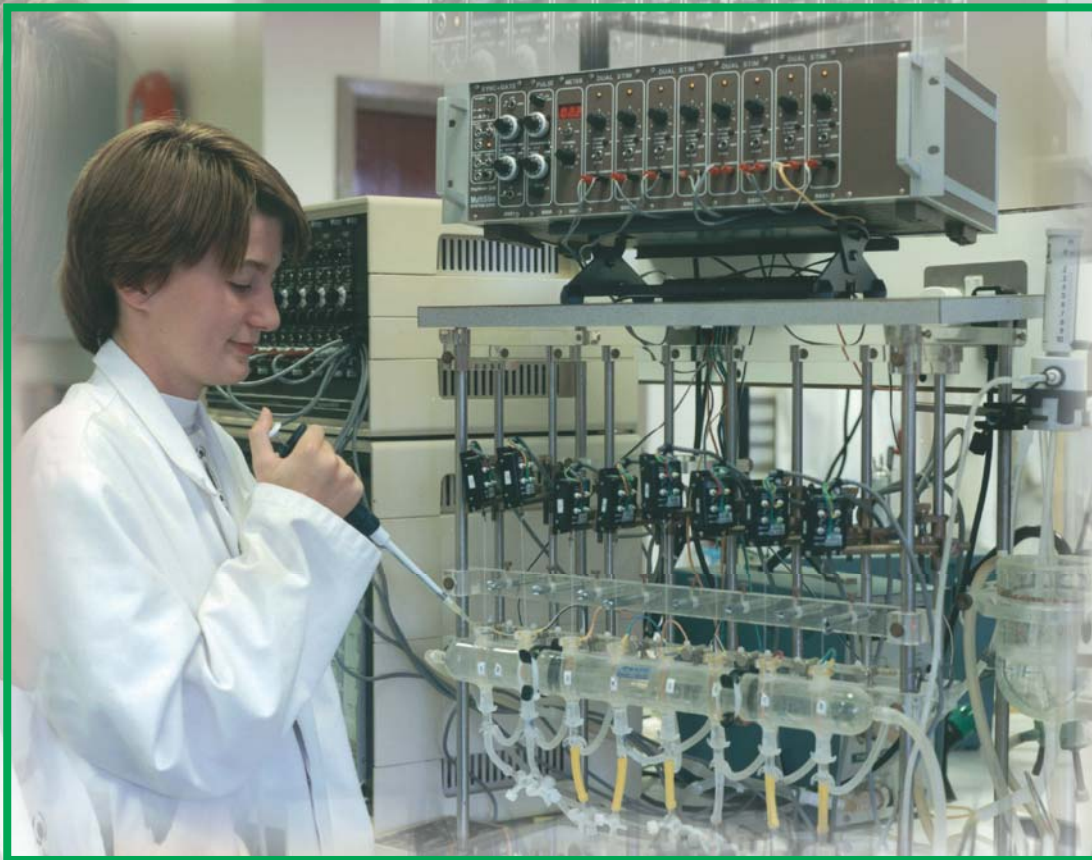

## STIMULATION FOR TISSUE BATHS

- **POWERFUL**
- **ACCURATE**
- **EASY TO USE**
- **MODULAR**

- **MULTI-CHANNEL**
- **REPEATABLE**
- **SELF-CONTAINED**
- **EXPANDABLE**

The D330-MultiStim System is a modular and highly versatile multi-channel stimulator designed to be used by scientists who wish to accurately stimulate a number of low impedance tissue preparations with different stimulating voltages or currents. The output channels are fully protected and galvanically isolated from ground so that a single earthing point can be chosen and loops avoided.

The system provides a choice of either constant voltage stimulation (up to 100V at 1A - D333H) or constant current stimulation (up to 500mA from a 100V source - D343). The D335 - Meter can be fitted into the system to allow precise voltage or current monitoring. A selection of timing modules are available to generate pulses, variable in frequency and width, which can be controlled as bursts using a gating waveform, variable in repetition rate and duration or pulse count. Sockets are fitted to allow full external control and synchronisation if required. The D330-MultiStim System rack/case is available in a 19" rack-mountable unit - D337, that can house the Gated Pulse Train Generators and up to ten stimulation channels.

The modularity of the system allows a system to be extended or split between smaller units for two sites.

# OPERATIONAL MODES

## Simple External Control

The figure shows the connections of the Gate and Pulse inputs in relation to the overall system. The waveforms show the function of the Gate and Pulse signals in relation to the stimulus output.

If the external Pulse starts before the Gate is 'high' (both external TTL signals in this example) no stimulus is produced (a). Similarly, if an external Pulse starts before the Gate has 'shut', the full pulse is passed as the stimulus output (b). In this way the Gate functions as an 'enabling' signal to 'whole-pulses' only.

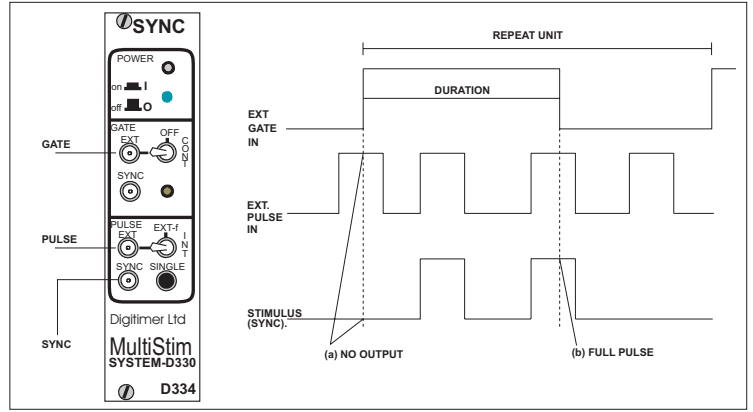

## External Gating of Internal Pulses

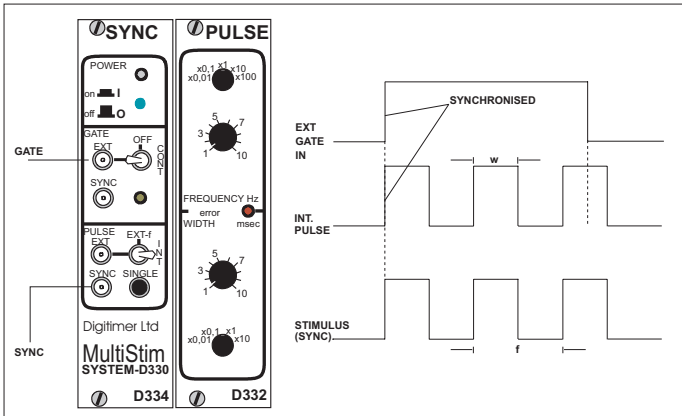

Here the Width (w) and Frequency (f) are being controlled internally by the D332/D332T. Note that Pulse 1 starts synchronously with the start of the Gate 'opening'. Note also that, since pulse 3 starts before the Gate 'closes', the whole pulse is delivered to the preparation.

## External Control with Internal Pulse Width

The situation here is similar to that shown above except that the pulse Frequency (f) is being controlled by the frequency of the external TTL input. The Width (w) of the stimuli, however, is still controlled by the D332/D332T module.

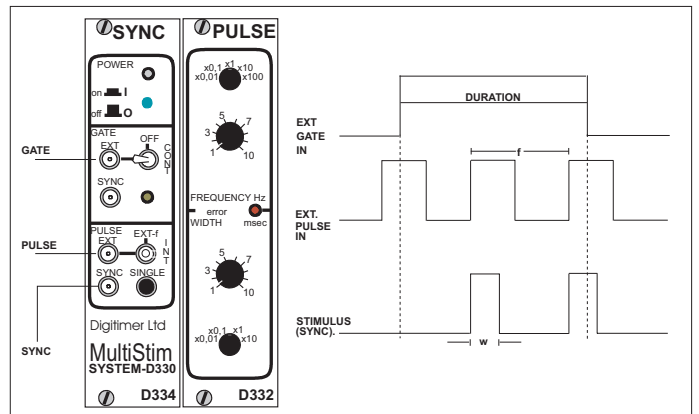

## Internal Control of Gate & Pulse

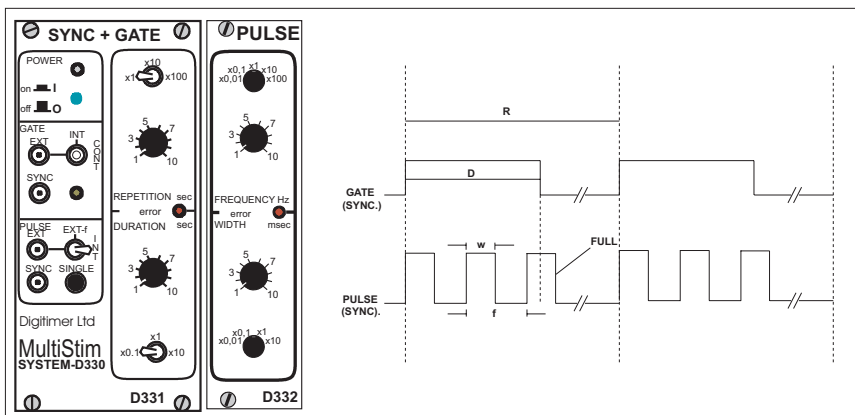

The D331AT module allows the user to set the Repetition Interval (R) and Gate Duration (D) independently. The pulse Frequency (f) and Width (w) are both controlled by the D332/D332T module.

If no internal control of the Gate is required, then the D334B can be substituted for the D331AT.

## Internal Control of Train & Pulses

The D341A module allows the user to set a fixed Number of Pulses ( $n$ ) within the gated Train. The pulse Frequency ( $f$ ) and Width ( $w$ ) are both controlled by the D332T module.

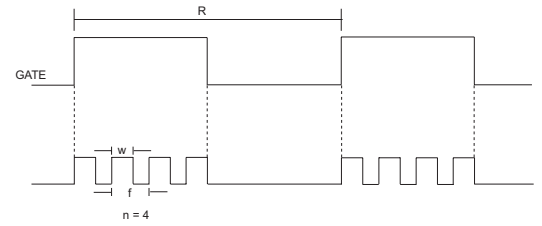
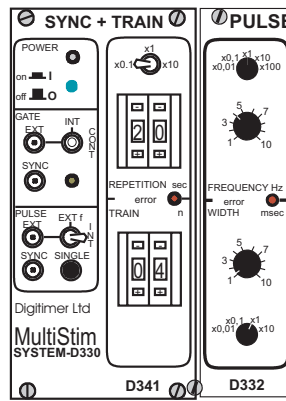

## (Additional) Delayed Pulse

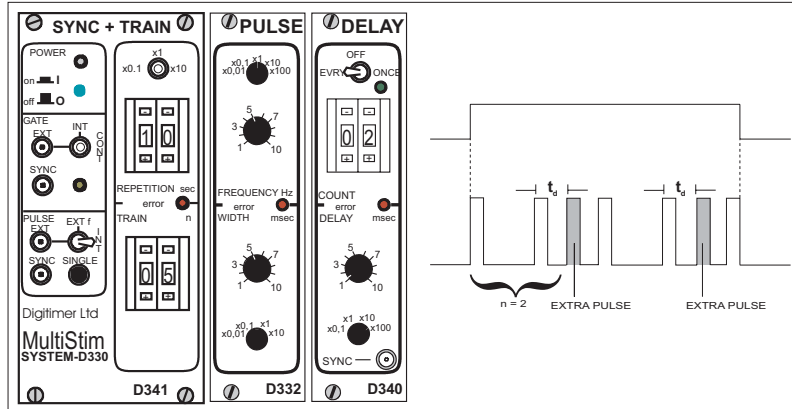

The addition of a D340 to the system enables a delayed extra pulse to be generated that can be used for determining Effective Refractory Period. In the example shown,  $\#d = 2$ , which means that an extra pulse is generated after every second pulse.  $t_d$  is the delay from the start of the second (02) pulse to the start of the additional pulse. The D340 module allows the extra pulse to be selected either after Every  $n$ th regular pulse within the gate (as shown) or just Once per Gate burst.

An internal jumper within the D340 allows the selection of just the delayed pulse being the stimulus.

## Independent External Logic Control

The D344 module accepts external TTL inputs to independently control the timing of each stimulation channel using multiple D333H/D343.

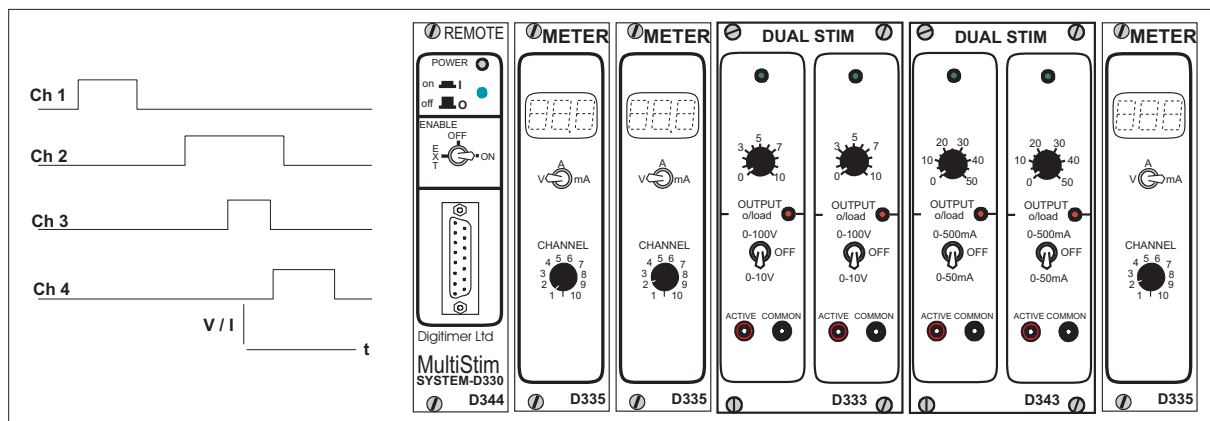

## Specific Requirements

The D330-MultiStim System can often be adapted to suit the user's own needs. For example, by factory modification, up to four D333H/D343 channels can be independently controlled by four separate D332T modules in the same rack.

## Protection & Indicators

Particular attention has been paid in the design to protect the unit and warn the user of incompatible settings. This could be too great a Width for the set Frequency on the D332T, too long a Duration for the set Repetition Rate on the D331AT or a preparation that requires too great a current for the set Voltage on the D333H. Red LEDs are fitted to indicate an erroneous setting or overload, and orange LEDs indicate each Output channel that is producing a stimulus. The power supply lines are each monitored and if any go out of limits, possibly due to excessive total current from the stimulating channels, the LED on the left-hand module (D331AT/334B/341A/344) changes from green (OK) to red (FAULT).

# D337 RACK & POWER SUPPLY UNIT



## INTRODUCTION

The MultiStim Rack and Power Supply Unit (D337) can accommodate up to ten channels of stimulation. The stimulating modules are fitted into the right-hand bays within the frame and a choice of timing modules into the left-hand side. One or more D335 - Meter modules can be fitted in almost any position. As the rack works with internal voltages of over 60V D.C., blank panels (D330-1/D330-2) must be fitted into unused positions to comply with the requirements of the laboratory safety standard EN 61010 - 1 : 1993. They must also be fitted to comply with EMC regulations. The D337 rack is fully finished with protective top and bottom covers so as to allow bench-top use., it can also be mounted in a 19" rack. The front feet fold down to allow better access in the bench-top situation.

## D337 SPECIFICATION SUMMARY

Case: Width: 482.6mm; Depth: 244.8mm; Height: 132.5mm (146.5mm inc. feet); Handles: Add 41mm to depth; Front feet: Fold down to raise front of unit by extra 54mm over the 132.5mm;

Covers: Fully enclosed with top and bottom vented;

Motherboard: Links timing and power to all channels and outputs from each channel for D335 - Meter and D337 Stimulus Output Socket.

Capacity: Accepts 14 single-width modules, allowing up to 10 stimulation channels using the D333/D343 - Dual Stim modules.

Stimulus Output Socket: Functions: Separate pins for ACTIVE and COMMON of each channel. A separate pin is provided for system ground;

Connector: 25-way female 'D' with hex-jack locking; Position: Rear panel.

## SYSTEM CAPACITY

The left-hand bay will contain a double width D331AT or D341A unless internal Gate control is not required when the D334B or D344 would be fitted. The next bay will contain the D332T (unless D344 fitted). A D340 may be fitted (unless D344 fitted) if room is available in the left-hand 4 bays. Stimulation modules are fitted starting at bay 5 and one, or more, D335 - Meters may be fitted. D330-1/D330-2 blank front panels will be fitted to unused bays.

# STIMULATORS & MONITORING MODULES

## D333H - Dual Stimulator

This unit provides constant voltage stimuli from 0 to 100V in amplitude with currents up to 1A into loads as great as 0.01 $\mu$ F. The voltage of the two channels is independently controlled by single turn controls and range selector switches. Each channel has an on/off switch, stimulus indicator and an overload detector/indicator.

The control and timing for the pulses is generated by selecting other modules from the D330-MultiStim System range.

The D335 - Meter can be used to indicate either the voltage or current of the selected channel immediately before the end of the stimulation pulse.

### SPECIFICATION SUMMARY (of each channel)

OUTPUT: Range Selector: 1) 0 - 100V, 2) OFF, 3) 0 - 10V; Amplitude: Single turn (270°) control marked 0 - 10, intermediary panel marks at each integer; Accuracy:  $\pm$ 1% at '1' and '10' marks on 100V range,  $\pm$ 2% at '1' and '10' marks on 10V range,  $\pm$ 5% at intermediary marks;

Minimum: At '10' output: <100mV; Current: 1A max.; Impedance: On - 0.25 $\Omega$ , Off - 22 $\Omega$ ; Rise/Fall time: <5 $\mu$ s/20 $\mu$ s.

OVERLOAD CUT-OUT: Limit: 1A per channel; Function: The output pulse duration is terminated; Reset: The overload cut-out is automatically reset after each pulse.

INDICATORS: Overload: Red LED that illuminates after each overload; Stimulus: Amber LED that illuminates for each stimulus.

## D343 - Dual Stimulator

This unit is similar to the D333H except that the stimuli generated are constant current. The fully protected unit provides control of stimulus strength up to 500mA from a 100V source into low impedance baths where impedances can be as high as 200 $\Omega$ .

### SPECIFICATION SUMMARY (of each channel, unless stated)

OUTPUT: Range Selector: 1) 0 - 500mA, 2) OFF, 3) 0 - 50mA; Amplitude: Single turn (270°) control marked 0 - 50, intermediary panel marks at 5, 10 .. 40, 45; Accuracy:  $\pm$ 2% at '50' mark,  $\pm$ 5% at other marks; Maximum (rack limit): 500mA from each of two channels at 50% mark-space ratio; Compliance: 100V  $\pm$ 5%; Rise/Fall times: <5 $\mu$ s/20 $\mu$ s.

INDICATORS: Compliance: Red LED that shows that the required current was not supplied; Stimulus: Amber LED that illuminates for each stimulus.

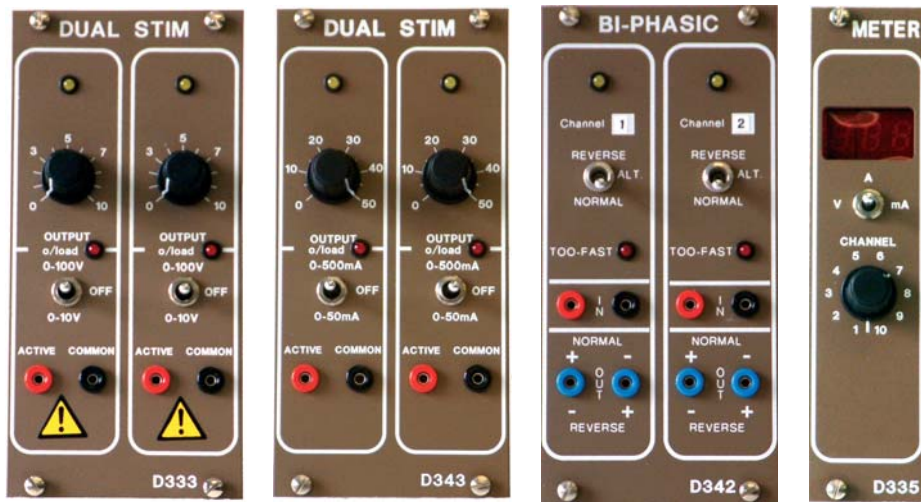

## D342 Dual Bi-Stim (Bi-phasic) Module

This unit provides a switching function allowing stimuli of alternating polarity to be presented to each of two preparations. It has control of stimulus polarity (Normal, Alternating or Reverse) independently for each channel as well as warning of a stimulus timing rate that is too-fast. The control and timing for the pulses is generated by selecting other modules from the D330 MultiStim range. It should be noted that the unit uses mechanical relays that require a certain time to switch their polarity. Therefore, the circuit will detect and warn the user if the 'time-between' stimuli pulses is less than 5ms. The module connects to the outputs of a D333 or D343 via 2mm-2mm leads (supplied). Each module is preset for specific channels whose outputs are to be switched. Normally, the unit will be supplied preset for channels 1 and 2 or as required when a full system is purchased.

## D335 - Meter Module

This module provides retained digital indication of the measured voltage or current of the stimulating waveform, thus making oscilloscopes to measure these parameters unnecessary. The measurement channel is selected from the front panel and the measurement is shown on three 7-segment LEDs. The converter is commanded to sample the selected channel coincident with the end of the output pulse to remove errors due to the capacitance of the preparation. This is possible as the stimulus control logic is very quick and the stimulus itself takes a few microseconds to react.

### SPECIFICATION SUMMARY

Display: 3 x 7-segment red LEDs - 0.3" high; Range: 00.0 - 99.9V, 0.00 - 9.99A, 000 - 999mA; Timing: Samples and converts selected channel coincident with the end of the output timing pulse; Selector: Ten-position rotary switch marked Channels 1 to 10.

# CONTROL & GATE MODULES

COMMON FEATURES (Gate only applies to D331AT, Train to D341A, Pulse to D331AT, D334B and D341A)

POWER: Switch: Mounting for the rod that activates the switch in the PSU, push on - push off; Error/Power On: Red/Green LED.

EXTERNAL CONNECTORS: Type: Lemo single pole (not D344); Control Inputs: TTL compatible, Triggers at +1.5V, maximum input  $\pm 15V$ , active high; Sync. Outputs: TTL compatible. Optionally: +15V pulse by on-board jumpers, active high.

GATE/TRAIN SELECTOR FUNCTIONS: 1) 'EXT' - External control of Repetition and Duration, 2) 'INT' - Internal control of Repetition and Duration, 3) 'CONT' - Pulses continuously enabled.

PULSE SELECTOR FUNCTIONS: 1) 'EXT' - External control of Frequency and Width, 2) 'EXT-f' - External control of Frequency, 3) 'INT' - Internal control of pulse Frequency and Width; Single (not D344): Push button to give a single output pulse irrespective of other settings.

NOTE: The internal pulse frequency and width would be set by a D332T - Pulse module.

## D334B - Sync

This module provides the front panel Power switch, power-on/error LED, Pulse & Gate External (EXT) In & Synchronisation (SYNC) sockets and a Single pulse button. The Gating circuitry has been carefully designed so that only 'whole' pulses are delivered to the preparations.

**SPECIFICATION SUMMARY:** See Common Features.

## D331AT - Sync & Gate

The right-hand side of this module provides control of the Gating function so that bursts of pulses can be delivered at an accurately set Repetition interval for accurately set Durations. The left-hand side of this module has the functions of the D334B.

### SPECIFICATION SUMMARY

GATE REPETITION: Total Range: 1 - 1100 seconds; Divider: Internal jumper for total range 0.1 - 110 seconds; Control: 10-turn (3600°) dial with lock, marked 1 - 11 and sub-marked in 1/10 and 1/50 turn; Accuracy:  $\pm 1\%$  through dial range.

GATE DURATION: Total Range: 0.1 - 110 seconds; Divider: Internal jumper for total range 0.01 - 11 seconds; Control: 10-turn (3600°) dial with lock, marked 1 - 11 and sub-marked in 1/10 and 1/50 turn; Accuracy:  $\pm 1\%$  through dial range.

## D341A - Sync & Train

The right-hand side of this module provides control of the Gating function so that a set Number of Pulses can be delivered at an accurately set Repetition interval. The left-hand side of this module has the functions of the D334B. If the Repetition time is set too short so that a second repetition command is requested during a burst, it is ignored; the requested Number of Pulses is completed and an error is indicated.

### SPECIFICATION SUMMARY

TRAIN REPETITION: Total Range: 0.1 - 990 seconds; Control: 01 to 99 by a two-digit thumb-wheel switch; Multiplier: x0.1, x1, x10; Ranges: 0.1 - 9.9s in 0.1s increments, 1 - 99s in 1s increments, 10 - 990s in 10s increments; Accuracy:  $\pm 1\%$ .

COUNT: Total Range: 01 - 99.



### D344 - Remote

This module allows the user full (and only) external control of the timing for each independent channel. A toggle switch gives overall output control by :- a) allowing a single external Enable signal to control the system, b) permanent Enable or c) all channels OFF (for safety).

#### SPECIFICATION SUMMARY

INPUTS: Channel: Ten off, 1 per channel; Enable: Active high, when low disables all channels; Connector: 15-way male 'D' with hex-jack locking.

OUTPUTS: Power: Ground and +5V limited to 20mA.

CONTROL: System Enable: 1) 'EXT'-External control of Enable; 2) 'OFF'-No output from any stimulator; 3) 'ON'-External enable overridden.

## PULSE TIMING MODULES

### D332T - Pulse

This module has the same features and specifications as the D332 except that both the Frequency and Width have a locking 10-turn dial control which also gives a slight increase in each range.

#### SPECIFICATION SUMMARY

FREQUENCY: Total range: 0.01 - 1100Hz; Control: 10-turn (3600°) dial with lock, marked 1 - 11 turns and sub-marked in 1/10 and 1/50 turn; Accuracy: ±1%.

WIDTH: Total range: 0.01 - 110ms; Control: 10-turn (3600°) dial with lock, marked 1 - 11 turns and sub-marked in 1/10 and 1/50 turn; Accuracy: ±1% through dial range.

### D340 - Count & Delay

This single width module will allow a stimulus pulse of the Width set on the D332 to be added to (or be the only pulse in) the output train at a selected Delay after a selected Number of pulses. This unit will be found useful in determining Effective Refractory Period.

#### SPECIFICATION SUMMARY

COUNT: Range: 01 - 99 by a two digit thumb-wheel switch; Selector: 1) Every nth pulse - Reset at start of Gate, then after every nth pulse within a Gate period, 2) OFF, 3) Once per Gate - After the nth pulse.

DELAY: Total range: 0.1ms - 1 second; Control: Single turn (270°) marked 1 - 10ms with intermediary integer panel marks; Accuracy: ±1% at '1' and '10' marks, ±5% at intermediary marks; Multiplier: x0.1, x1, x10, x100 by 4-position rotary switch.

INDICATORS: Error: Red LED; Sync. Pulse: Amber LED.

SYNC.: Output: TTL output for external monitoring. Optionally: +15V pulse by on-board jumper; Selection: Internally selected by on-board jumpers as: - a) the pulse that triggers the delay, b) the delayed pulse, c) both the triggering and delayed pulses.



### D340T - Count & Delay

This module has the features and specifications of the D340 except that the Delay has a locking 10-turn control which gives a slight increase in range.

**SPECIFICATION SUMMARY** as D340 except:-

DELAY: Total range: 0.1 - 1.1 seconds; Control: 10-turn (3600°) dial with lock, marked 1 - 11 turns and sub-marked in 1/10 and 1/50 turn; Accuracy: ±1% through dial range.

# ACCESSORIES

## Blank Panels

These are matching blank front panels complete with mounting hardware to complete the enclosure of the front aperture for safety and aesthetics. Size: D330-1 is one module unit wide; D330-2 is two module units wide.

## D330-10 Output Extension Lead

This is an extension lead and connection box for all stimulation channels. On one end there is a 25-way male 'D' connector, with screw-lock retainers, that mates with the Stimulus Output socket on the rear of the D337- Case. The cable is, nominally, 2 meters long and an insulated connection box with 2mm sockets is fitted to the other end.

Cable Length: 2m (nom.) - other lengths to special order. This is specified as: D330-10/5m, a D330-10 with nominal 5m of lead ( $\pm 0.1m$ );

Connections: Pair of 2mm sockets (with compliance) for each channel. ACTIVE - Red socket, goes positive wrt COMMON. COMMON - Black socket. GROUND - Green 2mm socket (two fitted); Box size: 120 x 65 x 40 [w x h x d - mm].

## Plugs, Adapters and Leads

No leads or connectors (except for a Mains lead) are supplied with a D330-MultiStim System. In addition to the preparation leads at least one lead is usually required for external synchronisation or monitoring.

Lemo Connectors and cables for Synchronisation and External In sockets

NL951: Cable with a connector on both ends; available in 5 standard lengths (15cm, 30cm, 45cm, 1m and 2m) - please specify length when ordering;

NL952: 2m cable with a connector at one end and tinned lead at the other; NL960: Adapter with BNC plug and Lemo socket that makes cables with BNC plugs at one end unnecessary; NL961: 'T' connector that is used to make branched connections at the front panel socket; NL962: Unassembled plug.

---

## Digitimer Ltd

37 Hydeway  
Welwyn Garden City  
Hertfordshire AL7 3BE  
ENGLAND

**Web:** [www.digitimer.com](http://www.digitimer.com)  
**E-mail:** [sales@digitimer.com](mailto:sales@digitimer.com)

**Tel:** (UK) 01707 328347  
(Int.) +44 1707 328347

**Fax:** (UK) 01707 373153  
(Int.) +44 1707 373153